

FRONT ELEVATION

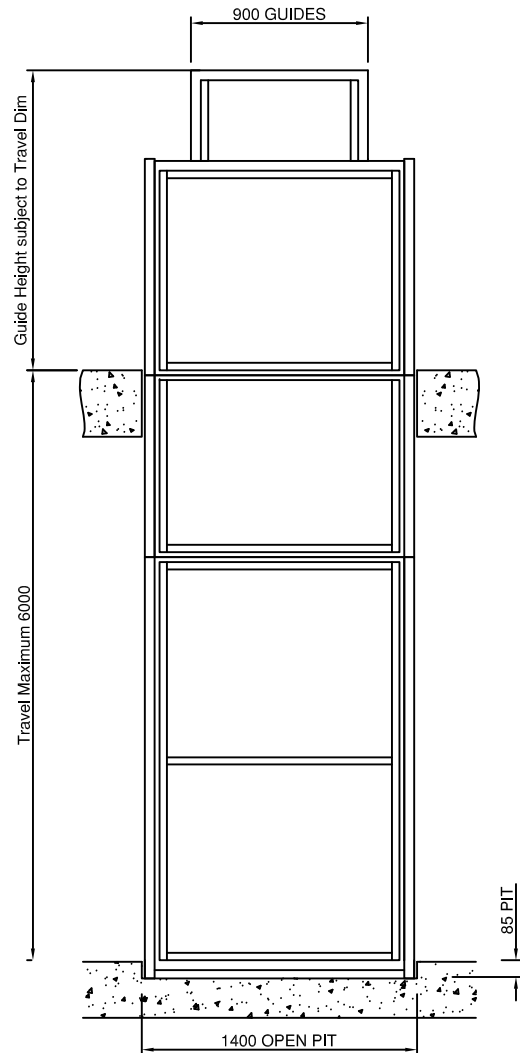

SIDE ELEVATION

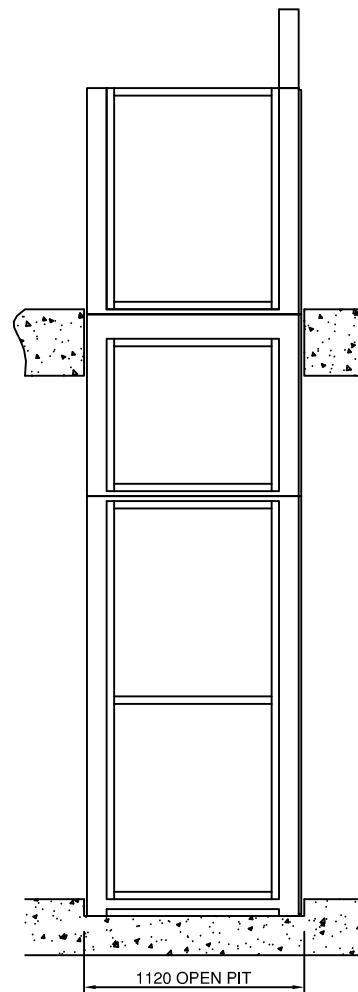

REAR ELEVATION

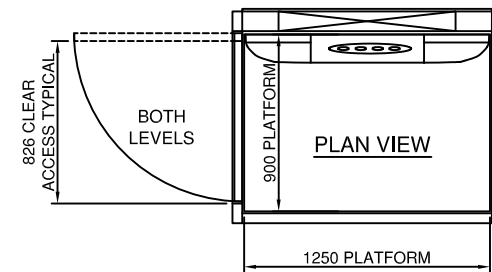

13 SP&N Supply to be terminated in an isolator adjacent to the control cubicle together with a BT Telephone point

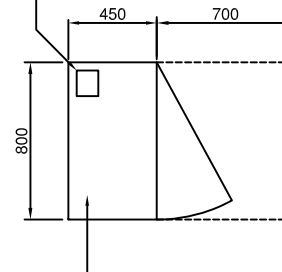

Control cubicle to be located within 5m of the inlet to the cylinder. 700 Clear working space to be provide to the front of the enclosure

Type	Disabled Access Platform Lift
Drive	Hydraulic side direct acting
Rated Load	400 Kg
Travel	Maximum of 6.0 metres
No. of Stops	Maximum of 2 Stops
Configuration	Front Opening
Supply	230v 1 Phase 50 Hz
Running Current	4.5 amps
Starting Current	18 amps
Enclosure	Steel/Glazed Panels
Door Type	Steel with Glazed Insert
Door Fire Rating	None

Issued for information only

BY	DATE	ISSUE	MODIFICATION	CHECKED

Hydraulic Platform Lift Standard Layout & Builders Work 1250 x 900
Platform Front Opening with Upper Gate

NICHE LIFTS Ltd	DRAWN BY	DATE	CHECKED	SCALE
	TMP	07.12.18		NTS
Do not scale this drawing. All dimensions in millimetres	DRAWING NUMBER			
	2110/1 Sheet 1 of 2			

CONSTRUCTION NOTES

THE FOLLOWING WORK SHALL BE COMPLETED PRIOR TO LIFT INSTALLATION PROCEDURE. ENSURE THE BUILDING FABRIC CAN WITHSTAND THE LOADS AS SHOWN.

WORKS BY OTHERS

1. Form a load bearing pit to the dimensions shown. If the lift is external make provisions to prevent standing water in the pit.
2. Provide a plumb foot print for the lift to the dimensions shown.
3. Provide a fixing point at the upper threshold for the lift fixings. Push pull load 100kg.
4. Provide a dedicated SP&N supply terminated in a lockable isolator as shown at the lower level.
5. Dedicated analogue telephone line adjacent to the isolator.
6. Provide a 100 diameter duct or trunking from the control cubicle in to the long side of the lift at the lower level.
7. Clear access to the installation area.
8. Assistance with offloading and distribution of the lift equipment.
9. Storage area close to the lift installation.
10. Fall protection at the upper levels.
11. Clear working area for installation.
12. Welfare facilities.
13. 110v power for tooling.
14. 230v external rated twin socket outlet close to the lift for future maintenance operations.
15. 50lux illumination at both levels for code compliance.
16. 200lux illumination at floor level in front of the control cubicle.
17. 1500 turning circle at both levels for disabled access.

TECHNICAL SPECIFICATION

- | | |
|--|----------|
| 1. CONTRACT LOAD | 400Kg |
| 2. PLATFORM SPEED IF TRAVEL EXCEEDS 1400mm | 0.1m/s |
| 3. CONTROL SYSTEM VOLTAGE | 24v |
| 4. POWER SUPPLY | 240v 13A |

ELECTRICAL DATA

- | | |
|---------------------|--------|
| 1. MOTOR | 0.55kW |
| 2. STARTING CURRENT | 18A |
| 3. RUNNING CURRENT | 4.5A |

FINISHES

- | | |
|---------------------------|---|
| 1. Lift Enclosure | TBA at contract stage |
| 2. Doors and Frames | TBA at contract stage |
| 3. Control Box | BS 22 B 15 Pearl Gray |
| 4. Carriage Centre Covers | Standard Anthracite (contrast for compliance) |
| 5. Carriage Side Panels | Standard Pearl (contrast for compliance) |
| 6. Carriage Floor | Black Studded Rubber |

CONTROL CABINET INFORMATION

OUR CONTROL CABINET WILL BE A WEATHER PROOF CONSTRUCTION TO IP65 STANDARD AND SHALL BE MOUNTED IN A SUITABLE POSITION NOT MORE THAN 5Mtrs FROM THE GUIDE BASE PLATE. BUILDER TO INSTALL A PLASTIC DUCT 100 X 100 FROM THE CUBICLE TO THE LIFT SHAFT AREA. THERE SHALL BE ADEQUATE LIGHTING AND ACCESS TO THE CONTROL CABINET FOR MAINTENANCE AND EMERGENCY PROCEDURES TO BE CARRIED OUT

WEIGHT: 90 - 140 Kg's

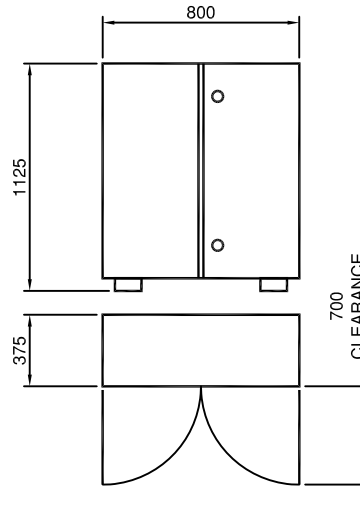

ENCLOSURE LOADING DIAGRAM

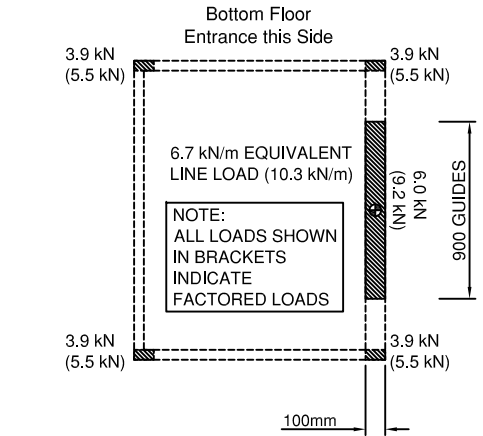

⊕ DENOTES THE POINT AT WHICH THE HYDRAULIC RAM IS PLACED.

THE OVERALL ENCLOSURE WEIGHT IS DEPENDANT ON THE FLOOR TO FLOOR TRAVEL DIMENSION.

THE ENCLOSURE LOADING DIAGRAM IS SHOWN FOR INFORMAL PURPOSES ONLY, AND IS BASED ON A LIFT OF 6000mm FFL / FFL AND AN ENCLOSURE WEIGHT OF 1750kgs.

TECHNICAL SPECIFICATION

- | | |
|--|----------|
| 1. CONTRACT LOAD | 400Kg |
| 2. PLATFORM SPEED IF TRAVEL EXCEEDS 1400mm | 0.1m/s |
| 3. CONTROL SYSTEM VOLTAGE | 24v |
| 4. POWER SUPPLY | 240v 13A |

ELECTRICAL DATA

- | | |
|---------------------|--------|
| 1. MOTOR | 0.55kW |
| 2. STARTING CURRENT | 18A |
| 3. RUNNING CURRENT | 4.5A |

FINISHES

- | | |
|---------------------------|---|
| 1. Lift Enclosure | TBA at contract stage |
| 2. Doors and Frames | TBA at contract stage |
| 3. Control Box | BS 22 B 15 Pearl Gray |
| 4. Carriage Centre Covers | Standard Anthracite (contrast for compliance) |
| 5. Carriage Side Panels | Standard Pearl (contrast for compliance) |
| 6. Carriage Floor | Black Studded Rubber |

Bottom Floor Entrance this Side

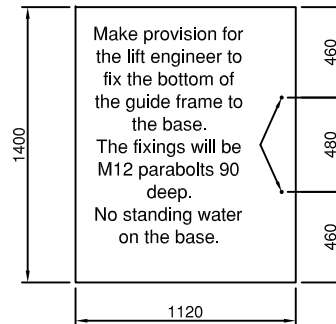

Base Dimensions and Guide Frame Drillings

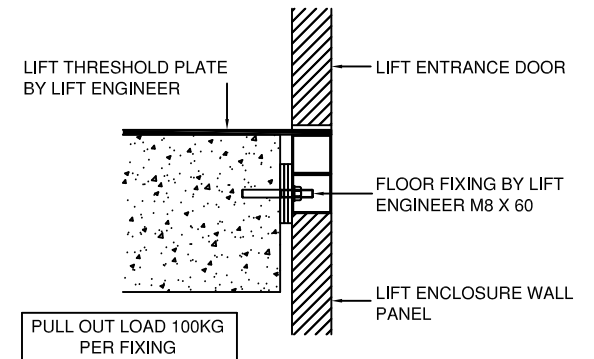

LIFT THRESHOLD FIXING DETAIL

Issued for information only

BY	DATE	ISSUE	MODIFICATION	CHECKED

Hydraulic Platform Lift Standard Layout & Builders Work 1250 x 900
Platform Front Opening with Upper Gate

NICHE LIFTS Ltd

Do not scale this drawing. All dimensions in millimetres

DRAWN BY	DATE	CHECKED	SCALE
TMP	07.12.18		NTS

DRAWING NUMBER

2110/1
Sheet 2 of 2